

Test 1

SECTION 1 Questions 1 - 10

Questions 1-4

Complete the table below.

Write **NO MORE THAN THREE WORDS AND/OR A NUMBER** for each answer.

University Club	Monday	Tuesday	Wednesday
Name of club	film	climbing	chess
Extra activities	discussions	1.....	2.....
Current number of members	3.....	40	55
Contact			

Questions 5-10

Complete the notes below.

Write **NO MORE THAN THREE WORDS** for each answer.

Details of climbing club:

- 5 meets.....
- 6 excursion to France in the.....
- 7 subscriptions paid.....

Benefits:

- 8 discounts on.....
- 9 annual.....
- 10 free entrance to climbing in Cardiff

SECTION 2 Questions 11 - 20

Questions 11 - 15

Which features are available at the following halls of residence?

Choose **FIVE** answers from the box and write the correct letter **A-G** next to Questions 11 - 15

- | List of Features | |
|-------------------------|--------------------|
| A | cleaning included |
| B | all meals included |
| C | private showers |
| D | modern building |
| E | parking spaces |
| F | single sex |
| G | sports facilities |

- | Halls of Residence | |
|---------------------------|-----------------------|
| 11 | Brown Hall |
| 12 | Blake Residence |
| 13 | Queens Building |
| 14 | Parkway Flats |
| 15 | Temple Rise |

Questions 16 - 20

Label the map below.

Write the correct letter *A - G* next to Questions 16 - 20.

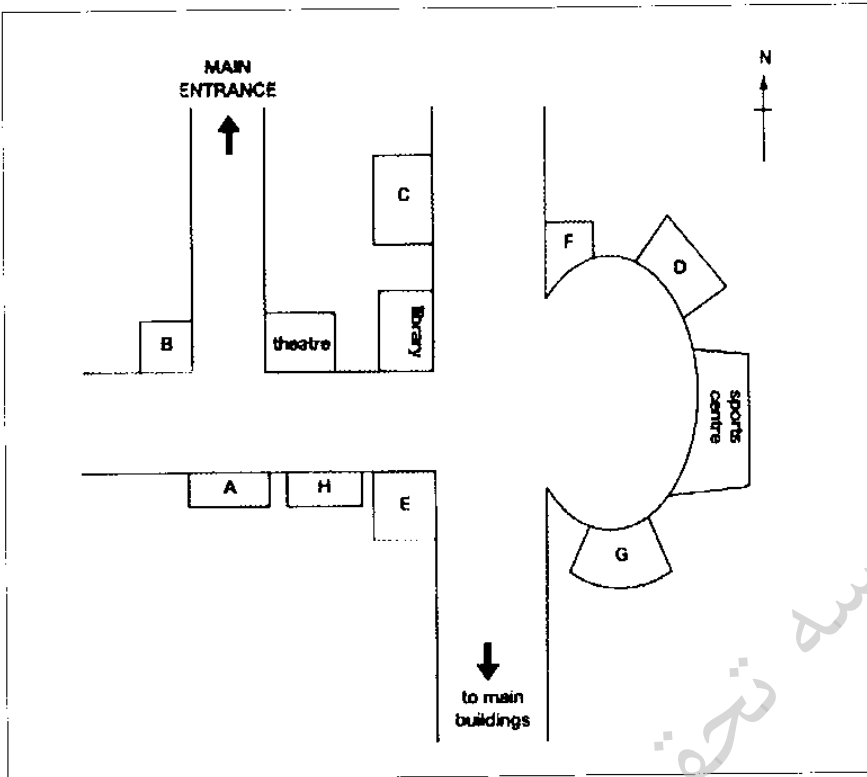

- 16 Brown Hall
- 17 Blake Residence
- 18 Queens Building
- 19 Parkway Flats
- 20 Temple Rise

SECTION 3 Questions 21 - 30

Questions 21- 24

Complete the sentences below.

Write **NO MORE THAN THREE WORDS OR A NUMBER** for each answer:

- 21 Jenna and Marco must complete their project by.....
- 22 The project will be a study of the increase in.....
- 23 The project will be assessed by
- 24 Jenna AND Marco agree they need a for the project.

Questions 25- 27

Choose **THREE** letters, **A-G**.

What **THREE** things do Marco and Jenna have to do now for the project?

- A interview some people
- B hand out questionnaires
- C choose their subjects
- D take photographs
- E use statistical software
- F do some work in the library
- G contact some local companies

Questions 28-30

Choose the correct letter, **A, B** or **C**.

- 28 Why did Jenna and Marco agree to work together?
 - A because they both wanted to work with someone else
 - B because they each have different skills
 - C because they have worked together before

- 29 Why does Marco suggest that he writes the analysis?
 - A He needs more practice with this kind of writing.
 - B He is better at English than Jenna.
 - C He has more experience of this than Jenna.

CRACK IELTS IN A FLASH (LISTENING)

- 30 Why does Jenna offer to do the presentation?
- A Her tutor wants her to do the presentation.
 - B Marco is very nervous about giving presentations.
 - C She wants to divide the work on the project fairly.

SECTION 4 Questions 31- 40

Questions 31-35

Of which US news source is each of the following statements true?

Write the correct letter, **A**, **B** or **C** next to Questions 31 - 35.

News Sources

- A television
- B Internet
- C the press

- 31 It is more popular at the weekend than during the week.
- 32 It has affected the popularity of local radio.
- 33 It has recently been able to expand internationally.
- 34 It is offering more varied reporting than previously.
- 35 It has suffered from government intervention.

Questions 36-40

Complete the summary below.

Write **NO MORE THAN TWO WORDS** for each answer.

Advertising and Newspapers

In the USA, newspapers are being increasingly inventive about the way they attract advertisers and their **36**..... now exceeds that of other industries.

Advertising has increased because of a good relationship with the **37**.....sector.

In addition, newspapers now run more adverts which include **38**..... These have been found to raise readership of the papers and create more sales for the

39..... . There is also an increasing number of more expensive

40..... adverts.

موسسه تحقیقاتی آرمان

Test 2

SECTION 1

Questions 1- 10

Questions 1 - 6

Complete the form below.

Write **NO MORE THAN TWO WORDS AND/OR A NUMBER** for each answer.

Student Union Registration Form	
Name:	Stefan Unger
Degree programme: 1
Department: 2
Leisure activities: 3
Language(s) (apart from English): 4
Type of accommodation: 5
Contact number: 6

Questions 7 -10

Answer the questions below.

Write **NO MORE THAN THREE WORDS** for each answer.

- 7 When can students use the photocopier?.....
- 8 Where are events usually held?
- 9 Which Union officer is responsible for van hire?.....
- 10 What will Union members be able to get a discount on?.....

SECTION 2 Questions 11 - 20

Questions 11 - 15

Label the plan below.

Choose FIVE answers from the box and write the correct letter A - G next to Questions 11-15.

- A Arts section
- B Computers
- C Languages section
- D Law
- E Magazines
- F Science
- G study desks

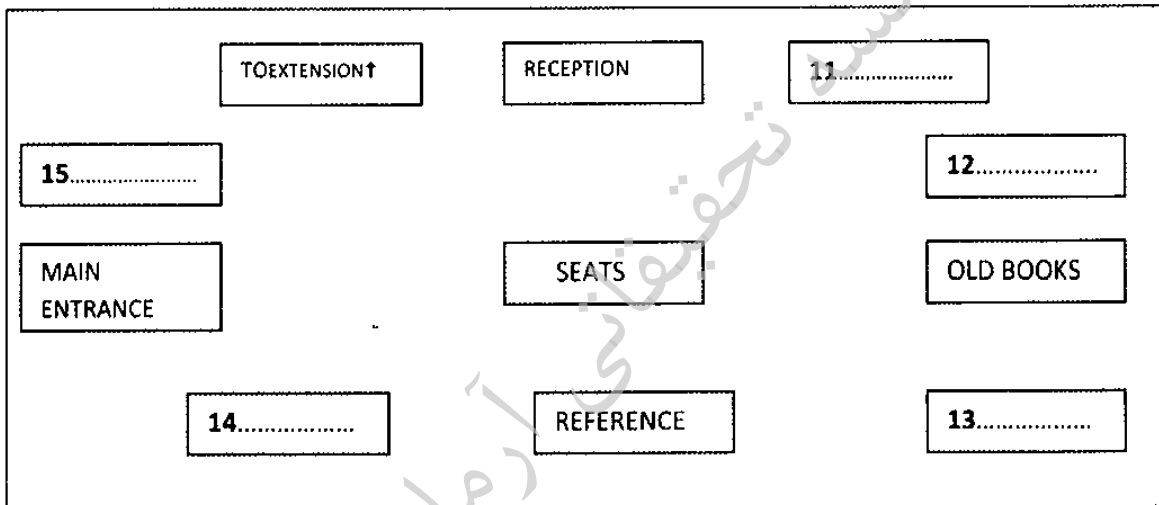

Questions 16-20

Complete the notes below.

Write NO MORE THAN TWO WORDS AND/OR A NUMBER for each answer.

Library system:

Maximum borrowing period: 16

Renew books in person or by: 17

Overdue charge: 18.....

Unavailable books: complete 19.....

Extra services: 20.....

SECTION 3 Questions 21-30

Questions 21 - 28

Complete the flow-chart below.

Write **NO MORE THAN TWO WORDS** for each answer.

To Submit a Paper for the Architecture Conference

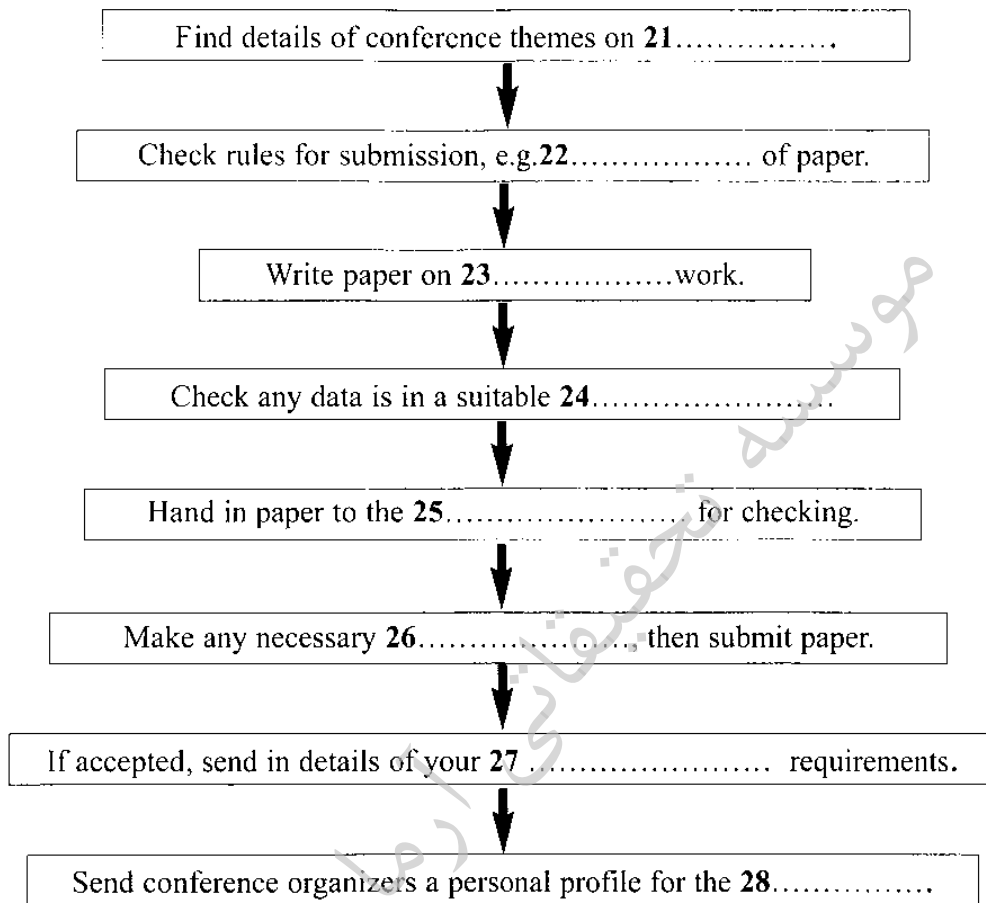

Questions 29 - 30

Choose **TWO** letters, A-E.

Which **TWO** things does Kirsten plan to do to prepare her conference paper?

- A read another student's thesis
- B collect more data
- C talk to some postgraduates
- D contact a professor at another university
- E inspect a building site

SECTION 4 Questions 31 - 40

Questions 31 - 35

Complete the sentences below.

Write **NO MORE THAN TWO WORDS** for each answer.

Mobile phones now have the technology to

- send **31**..... of where the sender is.
- watch **32**..... in real time
- send **33** with texts
- inform students about lectures which are **34**.....
- transfer **35**..... to a computer.

Questions 36 - 40

Which group of people are the main users of mobile phones for the following purposes?

Write the correct letter, **A, B or C** next to Questions 36-40.

- | |
|---|
| <p>A women
B men
C men and women</p> |
|---|

- | |
|--|
| <p>Ways of Using Mobile Phones</p> <p>36 to access information.....
37 to stay in touch.....
38 for business.....
39 to store personal photos.....
40 as a camera.....</p> |
|--|

Test 3

SECTION 1 Questions 1 - 10

Questions 1-7

Complete the notes below.

Write **NO MORE THAN THREE WORDS AND/OR A NUMBER** for each answer.

Courses Available

writing in first term

1 in second term

2throughout the year

3during long vacation

Class sizes: 4 maximum

Course costs often paid by the 5

Exams available in 6

Must enroll by 7

Questions 8 - 10

Choose **THREE** letters, **A - G**.

Which **THREE** items does the student need to bring to the first class?

- A** passport
- B** computer desk
- C** note from tutor
- D** notebook
- E** student identity card
- F** dictionary
- G** registration form

SECTION 2 Questions 11 - 20

Questions 11 - 15

Of which type of transport is the following true?

Write the correct letter, A, B or C next to Questions 11 - 15.

- | |
|--|
| <p>A tube
 B train
 C bus</p> |
|--|

Features of Transport

- 11** cheapest
- 12** most convenient
- 13** fastest
- 14** most frequent service

Questions 16 - 20

Label the map below

Write the correct letter, A - G, next to Questions 16 - 20.

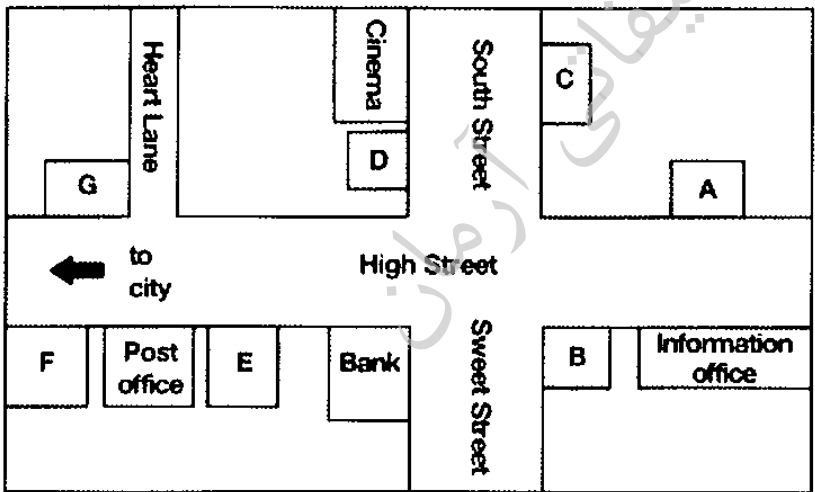

- 16** bus stop
- 17** train station
- 18** tube entrance
- 19** transport ticket office
- 20** taxi rank

SECTION 3 Questions 21 - 30

Questions 21 - 23

What is the advantage of each course?

Choose **THREE** answers from the box and write the correct letter **A - E** next to Questions 21 - 23.

- | |
|--|
| <p>Advantages of the Course</p> <ul style="list-style-type: none">A will be tested in the final examsB will be useful for a future jobC will help with research skillsD will improve writing skillsE will support material already covered |
|--|

Courses

- 21** Science and Ethics
- 22** Pharmacology Prelim
- 23** Reporting Test Results

Questions 24 - 30

Complete the sentences below.

Write **NO MORE THAN TWO WORDS** for each answer.

- 24** The Maths course will run in the
- 25** The tutor for Pharmacology is visiting from
- 26** for the project must be submitted by the end of January.
- 27** Resources for experiments are available in the
- 28** Extra will be held in December.
- 29** Students are allowed to do presentations in
- 30** Course assessment will be based on

SECTION 4 Questions 31- 40

Questions 31 - 37

Complete the table below.

Write **NO MORE THAN TWO WORDS** for each answer.

	New Features	Size	Problems
transport	individual transportation	roads will be narrower	level of investment
commercial areas	roofs will have 31	32of current area	33will be limited to outskirts
residential areas	homes made of 34	will be limited to 15,000	providing enough housing for 35
energy sources	36will be an energy source	energy plants will be smaller	noise and congestion caused by 37

Questions 38 - 40

Answer the questions below

Write **NO MORE THAN TWO WORDS** for each answer.

Which three types of accommodation does the speaker say will increase in city centers?

38

39

40

Test 4

SECTION 1

Questions 1 - 10

Questions 1 - 4

Complete the form below.

Write **NO MORE THAN THREE WORDS AND/OR A NUMBER** for each answer.

DVD Customer Profile
Occupation: student
Have you owned a DVD player before? NO
What is the maximum you want to spend on a DVD player? 1
How often do you watch DVDs? 2
What type of films do you enjoy? 3
What other DVDs (non-film) do you watch? 4

Questions 5 - 10

Complete the table below.

Write **NO MORE THAN TWO WORDS AND/OR A NUMBER** for each answer.

Player	Features	Cost	After-sales service
DB 30	Basic	£69	5only
XL 64	Can also 6	7	8at reduced cost
TriX	Will also play 9	£94 including	Guaranteed for 3 years

SECTION 2 Questions 11 - 20

Questions 11 - 20

Complete the sentences below.

*Write **NO MORE THAN THREE WORDS** for each answer.*

Your home:

- 11 A quarter of break-ins through the
- 12 The of the house should also be protected.
- 13 You should warn burglars your house is alarmed by putting a in the window.

The alarms:

- 14 The alarms show a constant
- 15 The alarms can be set off by a
- 16 The alarms are connected to the

Installation:

- 17 The alarms are usually installed in.....
- 18 The security code should be kept
- 19 The alarms can be installed at an additional cost.
- 20 Customers can pay for their alarm system.

SECTION 3 Questions 21 - 30

Questions 21 - 27

Complete the summary below.

*Write **ONE WORD ONLY** for each answer.*

Essay Writing

Essay writing is simply the process of **21**.....information and presenting your **22**..... You will need to use skills of analysis, **23**.....and expression. The more essays you write, the more you will develop these skills. The key to producing a good essay is in the **24**..... Allow plenty of time to work out what you need to do. You will find several books in the library to help you with the particular **25**..... of academic writing. When you have completed your essay, you must remember to **26**..... it carefully and take out anything irrelevant. Also, once you have received your mark, you should check your essay through as, by doing this, you can **27**..... from it.

Questions 28- 30

Choose **THREE** letters, A- G.

*Which **THREE** pieces of advice does the tutor give the student?*

- A break the question down into smaller question
- B check the vocabulary in the question
- C limit how much you read
- D make sure you have good notes
- E use only a few quotations
- F ask a friend to read your essay
- G try to be objective

SECTION 4 Questions 31 - 40

Questions 31 -36

Complete the flow chart below. Write ONE WORD ONLY for each answer:

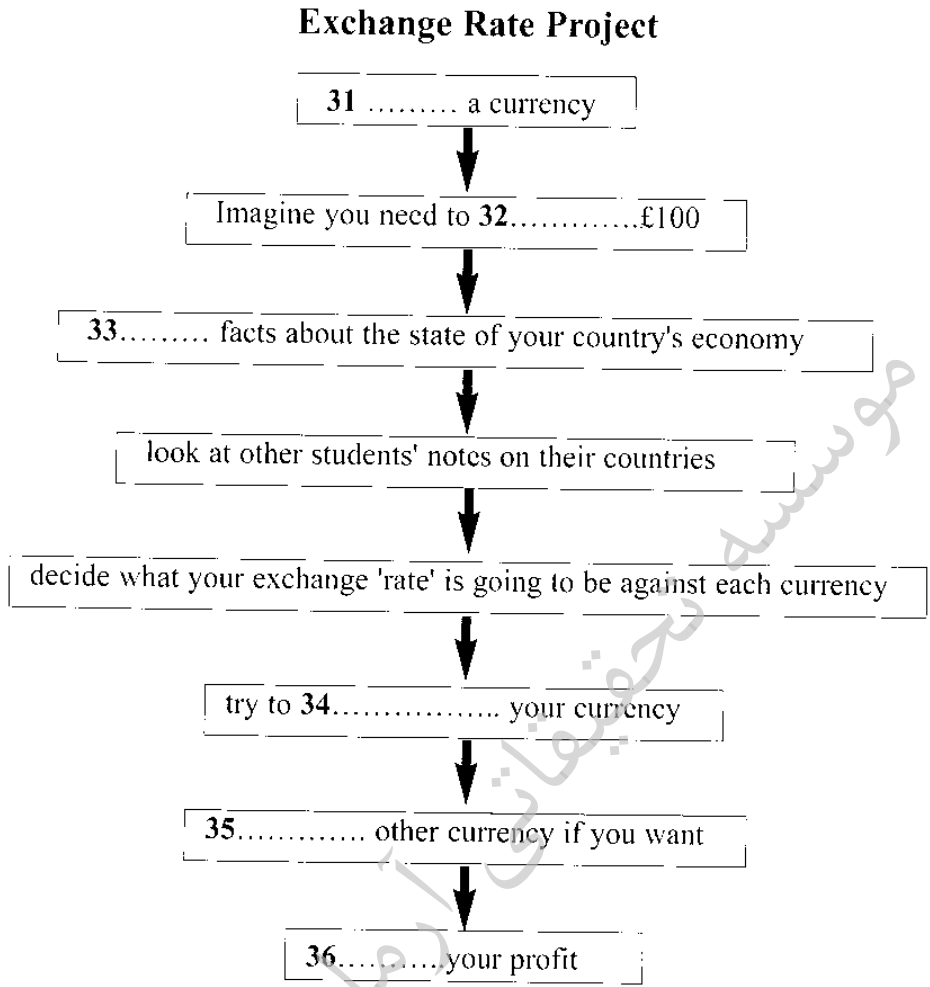

Questions 37 - 40

Answer the questions below.

Write **NO MORE THAN THREE WORDS AND/OR A NUMBER** for each answer:

- 37 How many main trading partners does the UK have?
- 38 Which sector does the tutor want students to study?
- 39 What does the tutor want student to look at changes in?
- 40 When does the tutor want the project completed by?

Test 5

SECTION 1

Questions 1-10

Questions 1-3

Listen to the telephone conversation between a student and the owner of a paragliding school and answer the questions below.

Circle the correct letters A-D

Example

Which course does the man suggest?

- A 2 day C 5 day
B 4 day D 6 day

1. How much is the beginner's course?

- A \$190
B \$320
C \$330
D \$430

2. What does the club insurance cover?

- A injury to yourself
B injury to your equipment
C damage to other people's property
D loss of personal belongings

3. How do girls want to travel?

- A public transport
B private bus
C car
D bicycle

Questions 4-7

Complete the form below. Write **NO MORE THAN THREE WORDS** for each answer.

TELEPHONE MEMO	
Name: Maria Gentle	
Address: C/O Mr & Mrs 4	
5	Newcastle
Fax no 0249 6	
Type of Card: 7.....	

Question 8

Circle **Two** letters **A-G**

Which **TWO** of the following items must people take with them?

- | | | |
|----------------------|----------------------------------|---------------------|
| A sandals | D shirt with long sleeves | G sunglasses |
| B old clothes | E soft drinks | |
| C pullover | F hat | |

Question 9

Circle **Two** letters **A-G**

Which **TWO** accommodation opinions mentioned are near the paragliding school?

- | | | |
|-----------------------|----------------------------|----------------------|
| A camping | D backpacker's inn | G cheap hotel |
| B youth hostel | E caravan park | |
| C family | F bed and breakfast | |

Question 10

Write **NO MORE THAN THREE WORDS** for your answer.

Which weekend do the girls decide to go?

.....

SECTION 2 Questions 11-20

Questions 11-20

Complete the notes below.

Write **NO MORE THAN THREE WORDS** for each answer.

Type of car: Duesenberg J- type

Number made: **11**

Type of body: **12**

Engines contained capsule of mercury to ensure a **13**.....trip.

Top speed: **14**..... per hour.

Sold as a **15**..... and

Main attraction: **16**.....

Type of car: Leyat Helica

Number built: **17**

Car looks like a **18**..... without **19**.....

Steering used the **20**

SECTION 3 Questions 21-23

Questions 21-22

Complete the notes below.

Write **NO MORE THAN THREE WORDS** for each answer.

Research details:

Title project: **21**.....

Focus of project: entertainment away from **22**

CRACK IELTS IN A FLASH (LISTENING)

Questions 23- 26

Circle the correct letters A-C.

23. Which chart shows the percentage of cinema seats provided by the different cinema houses?

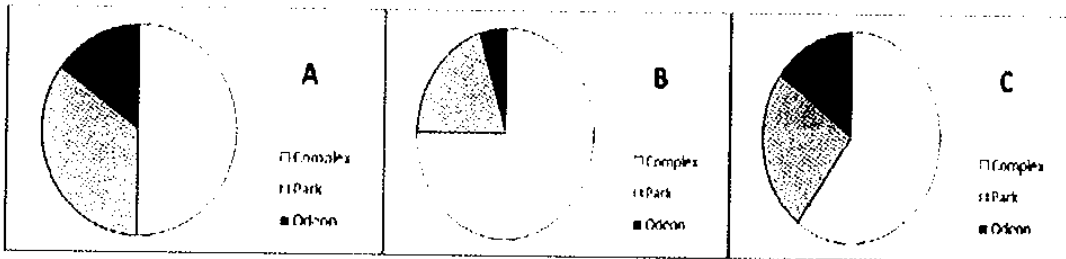

24. Which graph shows the relative popularity of different cinemas?

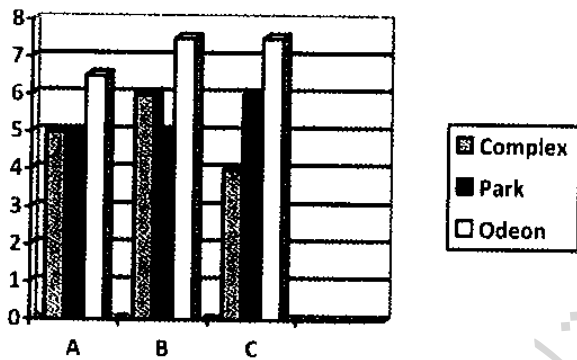

25. What did Rosie and Mike realize about the two theatres?

- A The prices were very similar.
- B They were equally popular.
- C They offered the same facilities.

26. Which graph shows comparative attendance for cinema and theatre?

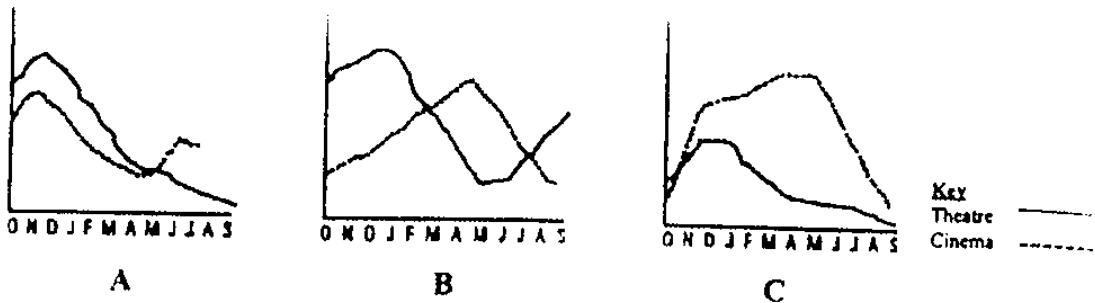

CRACK IELTS IN A FLASH (LISTENING)

Questions 27-30

Complete the chart about the different music clubs below.

Write **NO MORE THAN THREE WORDS** or use **ONE** of the symbols for each answer.

× poor ok ✓ excellent ✓ ✓

Club	Type of music	Quality of venue
The Blues Club	Blues	27.....
The Sansue	28.....	✓ ✓
Pier Hotel	Folk	29.....
Baldrack Café	Rock	30.....

SECTION 4 Questions 31-40

Questions 31-32

Complete the notes using **NO MORE THAN THREE WORDS** for each answer.

Main focus of lecture: the impact of 31..... on the occurrence of dust storms.

Two main types of impact:

- A) break ground surface, e. g. off-road vehicle use
- B) remove protective plants, e.g. 32..... and

Questions 33-36

Complete the table using **NO MORE THAN THREE WORDS** for each answer.

Name of area	Details
USA 'dust bowl'	Caused by mismanagement of farmland Decade renamed the 33
West Africa	Steady rise in dust storms over 20- year period
Arizona	Worst dust clouds arise from 34 Dust deposits are hazardous to 35
Sahara	Increased wind erosion has occurred along with long-term 36

Questions 37-40

Complete the flow chart using **NO MORE THAN THREE WORDS** for each answer.

Drying-up of Aral Sea

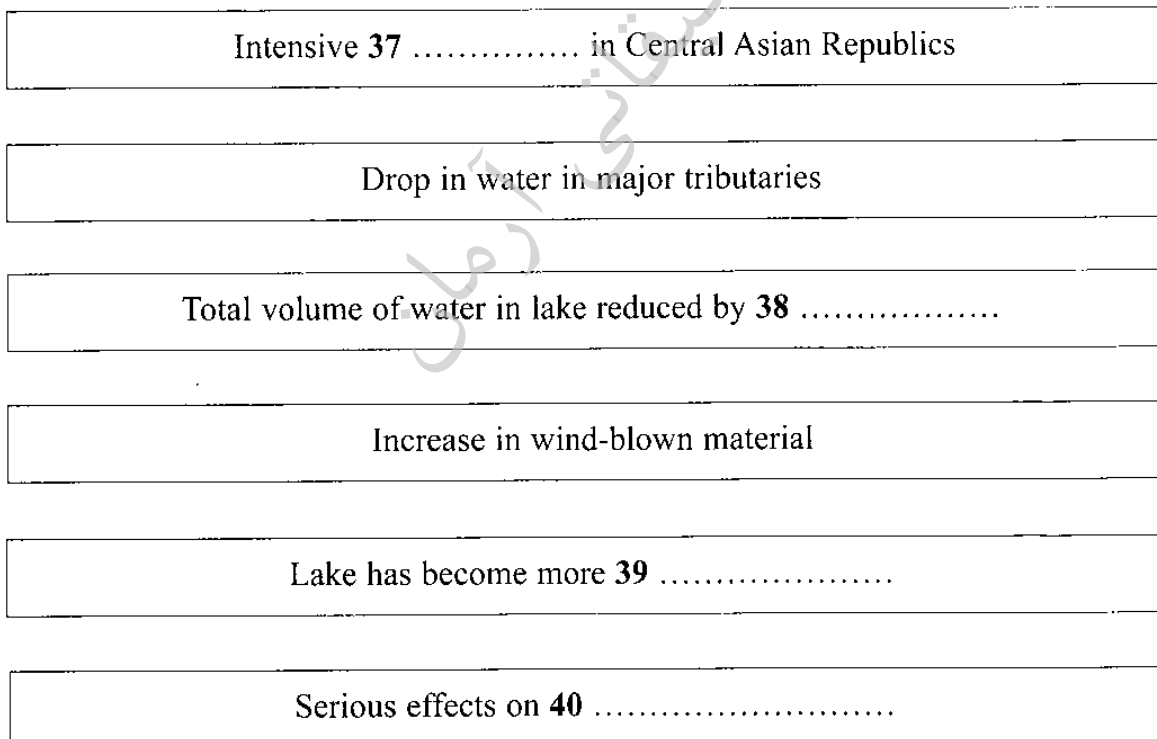

Test 6

SECTION 1

Questions 1-10

Questions 1-4

Circle the correct letters A-C.

Example

Which course is the man interested in?

- A English
- B Mandarin
- C Japanese

- 1 What kind of course is the man seeking?
 - A Daytime
 - B Evening
 - C Weekends

- 2 How long does the man want to study?
 - A 12 weeks
 - B 6 months
 - C 8 months

- 3 What proficiency level is the student?
 - A Beginner
 - B Intermediate
 - C Advanced

- 4 When does the man want to start the course?
 - A March
 - B June
 - C September

Questions 5-10

Complete the form.

Write **NO MORE THAN THREE WORDS** for each answer.

Language Center

Client Information Card

Name: *Richard* **5**.....

E-mail address: **6**..... @ *hotmail.com*

Date of birth: **7**..... *1980*

Reason for studying Japanese: **8**.....

Specific learning needs: **9**.....

Place of previous study (if any): **10**

SECTION 2 Questions 11-20

Questions 11-12

Complete the sentences below.

Write **NO MORE THAN THREE WORDS** for each answer.

11 The story illustrates that dogs are animals.

12 The people of the town built a of a dog.

Questions 13-20

Complete the table below.

Write **NO MORE THAN THREE WORDS** for each answer.

TYPE OF WORKING DOG	ESSENTIAL CHARACTERISTICS FOR THE JOB	ADDITIONAL INFORMATION
Sheep	Smart, obedient	Herd sheep and 13 them
Guide dogs	Confident and 14	Training paid for by 15
Guide dogs and 16 anddogs	Tough and courageous	Dogs and trainers Available through 17
Detector dogs	Need to really 18	In Sydney they catch 19 a month
Transport dogs	Happy working 20	International treaty bans huskies from Antarctica

SECTION 3 Questions 21-30

Questions 21-23

Complete the notes below.

Write **NO MORE THAN THREE WORDS** or **A NUMBER** for each answer:

Braille- a system of writing for the blind

- Louis Braille was blinded as a child in his **21**
- Braille invented the writing system in the year **22**
- An early writing system for the blind used embossed letters.
- A military system using dots was called **23**

CRACK IELTS IN A FLASH (LISTENING)

Questions 24- 27

Circle the correct letters **A-C**.

24 Which diagram shows the Braille positions?

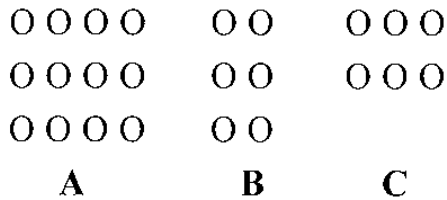

25 What can the combined dots represent?

- A both letters and words
- B only individual words
- C only letters of the alphabet

26 When was the Braille system officially adopted?

- A as soon as it was invented
- B two years after it was invented
- C after Louis Braille had died

27 What is unusual about the way Braille is written?

- A It can only be written using a machine.
- B The texts have to be read backwards.
- C Hand written Braille is created in reverse.

Questions 28-30

List **THREE** subjects that also use a Braille code.

Write **NO MORE THAN THREE WORDS** for each answer.

- 28
- 29
- 30

SECTION 4 Questions 31-40

Questions 31-35

Complete the notes below.

Write **NO MORE THAN THREE WORDS or A NUMBER** for each answer.

Question: Can babies remember any **31**.....?

Experiment with babies:
 Apparatus: baby in cot
 Colorful mobile
 Some **32**
 Re-introduce mobile between one and **33**later.

Table showing memory test results

Baby's age	Maximum memory span
2 months	2 days
3 months	34
21 months	Several weeks
2 years	35

Questions 36-40

Research questions: Is memory linked to **36** development?

Can babies **37** their memories?

Experiment with older children:

Stages in incident:

- a) lecture taking place
- b) object falls over
- c) **38**.....

Table showing memory test results

Age	% remembered next day	% remembered after 5 months
Adults	70%	39
9- year-olds	70%	Less than 60%
6-year-olds	Just under 70%	40

موسسه تحقیقاتی آرمان

Test 7

SECTION 1

Questions 1-10

Questions 1-4

Complete the form below.

Write **NO MORE THAN THREE WORDS** or **A NUMBER** for each answer:

Conference Registration Form

Example

Name of Conference: Beyond 2000

Name: Melanie 1 Ms

Address: 2 Room at Newtown

Faculty: 3

Student No: 4

موسسه تحقیقاتی آرمان

Questions 5-10

Circle the correct letters A-C.

Registration for:	5	A	Half day
		B	Full day
		C	Full conference
Accommodation required:	6	A	Share room/share bathroom
		B	Own room/share bathroom
		C	Own room with bathroom
Meals required:	7	A	Breakfast
		B	Lunch
		C	Dinner
Friday SIGs:	8	A	Computers in Education
		B	Teaching Reading
		C	The Gifted Child
Saturday SIGs:	9	A	Cultural Differences
		B	Music in the Curriculum
		C	Gender Issues
Method of payment:	10	A	Credit Card
		B	Cheque
		C	Cash

SECTION 2 Questions 11-20

Questions 11-20

Complete the table below.

Write **NO MORE THAN THREE WORDS** for each answer.

Name of Beach	Location	Geographical Features	Other information
Bandela	1km from Bandela 11	surrounded by 12	safe for children/ non-swimmers
Da Porlata	east corner of island	area around beach is 13	can hire 14 and
San Gett	Just past 'Tip of Caln'	15 beach on island	check 16 on beach in rough weather
Blanaka	17..... corner	surrounded by 18	can go caving and driving
Dissidor	close to Blanaka	need to walk over 19	need to take some 20 and

SECTION 3 Questions 21-30

Questions 21-30

Complete the notes below.

Write **NO MORE THAN THREE WORDS or A NUMBER** for each answer.

Procedure for Bookshops

- keep database of course / college details.
- In May, request **21**..... from lecturers.
- Categorise books as - essential reading
 - 22** reading
 - background reading

When ordering, refer to last year's **23**

- type of course
- students' **24**
- own judgment

Procedure for Publishers

- Send **25** to course providers
- Use websites
- Compose personal **26** to academic staff
- Send **27** to bookstores

Students

Main objective is to find books that are good **28**

Also look for books that are **29**..... and **30**

SECTION 4 Questions 31-40

Question 31

Circle the correct letters A-C.

31 At the start of her talk Rebecca points out that new graduates can find it hard to

- A** get the right work
- B** take sufficient breaks.
- C** motivate themselves.

Questions 32-33

Circle TWO letters A-E.

Which **TWO** of the following does Rebecca say worry new artists?

- A** earning enough money
- B** moving to a new environment
- C** competing with other artists
- D** having their work criticized
- E** getting their portfolios ready

Questions 34-35

Circle the correct letters A-C.

34 Rebecca decided to become an illustrator because it

- A** afforded her greater objectivity as an artist.
- B** offered her greater freedom of expression.
- C** allowed her to get her work published.

35 When she had developed a portfolio of illustration, Rebecca found publishers

- A** more receptive to her work.
- B** equally cautious about her work.
- C** uninterested in her work.

Questions 36-40

Complete the notes below.

Write **NO MORE THAN THREE WORDS** for each answer.

Suggestions for Developing a portfolio

Get some artwork printed in magazines by entering **36**

Also you can **37** and mock up book pages.

Make an effort to use a variety of artistic **38**

Aim for recognition by dividing work into distinct **39**

Possibly use **40**

موسسه تحقیقاتی آرمان

Test 8

SECTION 1

Questions 1-10

Questions 1-10

Complete the notes below.

Write **NO MORE THAN THREE WORDS or A NUMBER** for each answer.

Event Details	
Type of event:	<i>Example</i> Dragon Boat Race
Race details	
Day & date:	1.....
Place:	Brighton 2
Registration time:	3
Sponsorship	
- aim to raise over	4 as a team and get a free t-shirt
- free Prize Draw for trip to	5
Team details	
- must have crew of 20 and elect a	6
- under 18s need to have	7 to enter
- need to hire	8
- advised to bring extra	9
- must choose a	10 for team

SECTION 2 Questions 11-20

Questions 11-15

Complete the notes below.

Use **NO MORE THAN THREE WORDS** for each answer.

KIWI FACT SHEET	
Pictures of kiwis are found on 11	and
The name 'kiwi' comes from its 12	
The kiwi has poor sight but a good 13	
Kiwis cannot 14	
Kiwis are endangered by 15	

Questions 16-17

Complete the notes below.

Use **NO MORE THAN THREE WORDS** for each answer.

Kiwi Recovery Program

Stage of program	Program involves
(16)	Looking at kiwi survival needs
Action	Putting science into practice
(17)	Schools and the website

Questions 18-20

Complete the notes below.

Use **NO MORE THAN THREE WORDS** or **A NUMBER** for each answer.

OPERATION NEST EGG

18

19

Chicks returned to wild

Results

Survival rate increased from **20** to

SECTION 3 **Questions 21-30**

Questions 21-24

Circle the correct letters A-C.

21. The professor says that super highways
- A. lead to better lifestyles
 - B. are a feature of wealthy cities
 - C. result in more city suburbs
22. The student thinks people
- A. like the advantages of the suburbs
 - B. rarely go into the city for entertainment
 - C. enjoy living in the city
23. The professor suggests that in five years' time
- A. City Link will be chocked by traffic
 - B. public transport will be more poplar
 - C. roads will cost ten times more to build
24. The student believes that highways
- A. encourage a higher standard of driving
 - B. result in lower levels of pollution
 - C. discourage the use of old cars

Questions 25-26

Label the two bars identified on the graph below.

Choose your answers from the box.

Percentage of people using public transport by capital city

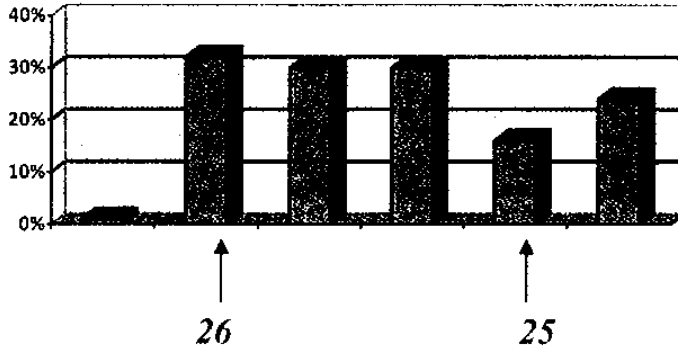

List of cities: Detroit Frankfurt London Paris Sydney Toronto

Questions 27-28

Circle **TWO** letters **A-F**.

Which **TWO** facts are mentioned about Copenhagen?

- A live street theatre encouraged
- B 30% of citizens walk to work
- C introduction of parking metres
- D annual reduction of parking spots
- E free city bicycles
- F free public transport

Questions 29-30

Circle **TWO** letters **A-F**.

Which **TWO** reasons are given for the low popularity of public transport?

- A buses slower than cars
- B low use means reduced service
- C private cars safer
- D public transport expensive
- E frequent stopping inconvenient
- F making connections takes time

SECTION 4 Questions 31-40

Questions 31-32

Complete the notes below.

Write **NO MORE THAN THREE WORDS** for each answer.

- | |
|---|
| <p>Reasons for preserving food</p> <ul style="list-style-type: none"> ● Available all year ● For 31 ● In case of 32 |
|---|

Questions 33-37

Complete the table below.

Write **NO MORE THAN THREE WORDS** for each answer.

Method of preservation	Advantage	Disadvantage
Ultra-high temperature (UHT milk)	33	spoils the taste
canning	inexpensive	risk of 34
refrigeration	stays fresh without processing	requires 35
36	effective	time-consuming
drying	long-lasting, light and 37	loses nutritional value

CRACK IELTS IN A FLASH (LISTENING)

Questions 38-40

Label the diagram.

*Write **NO MORE THAN THREE WORDS** for each answer.*

Roller drying

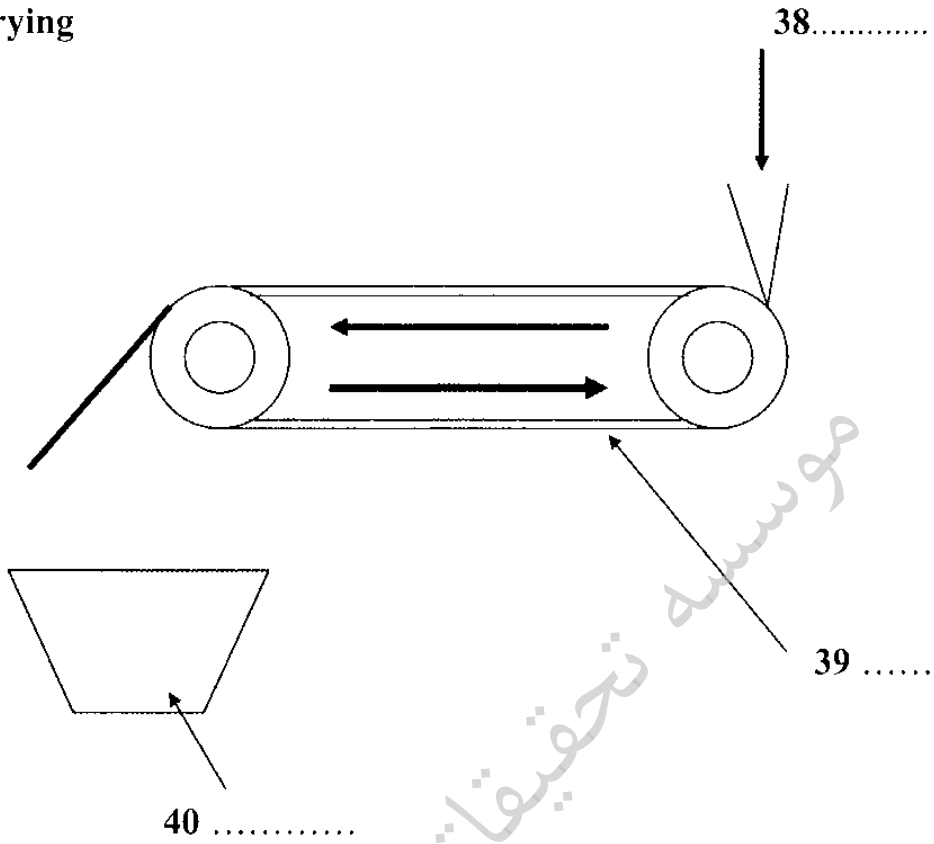

Test 9

SECTION 1

Questions 1-10

Questions 1-6

Complete the table below.

Write **NO MORE THAN THREE WORDS** or **A NUMBER** for each answer.

Millennium Office Supplies	
CUSTOMER ORDER FORM	
Example:	
ORDER PLACED BY	<i>John Carter</i>
Account Number	1.....
Company Name	2.....
Envelopes	
Size	<i>A4 normal</i>
Color	3.....
Quantity	4.....
Photocopy paper	
Color	5.....
Quantity	6.....

Questions 7-9

List **THREE** additional things that the man requests.

Write **NO MORE THAN THREE WORDS** for each answer.

- 7.
- 8.
- 9.

Question 10

Complete the notes.

Write **NO MORE THAN THREE WORDS** for your answer.

Special instructions: Deliver goods **10**

SECTION 2 **Questions 11-20**

Questions 11-20

Complete the notes below.

Write **NO MORE THAN THREE WORDS** for each answer.

Artist's Exhibition	
General details:	
Place: 11	No. 1 12
Dates: 6th October - 13	
Display details:	
● jewellery	
● furniture	
● ceramics	
● 14	
● sculpture	
Expect to see:	crockery in the shape of 15
	silver jewellery, e.g. large rings containing 16
	a shoe sculpture made out of 17
Go to demonstrations called: 18	
Artist's Conservatory	
Courses include:	Chinese brush painting
	19
	silk painting
Fees include:	Studio use
	Access to the shop
	Supply of 20

SECTION 3

Questions 21-30

Questions 21-23

Complete the sentences below.

Write **NO MORE THAN THREE WORDS** for your answer.

According to Alison Sharp

21 Bear ancestors date backyears.

22 Scientists think bears were originally in the same family as

23 The Cave Bear was not dangerous because it

Questions 24-28

Complete the grid. Tick (✓) the relevant boxes in each column.

Bear species	Sloth Bear	Giant Panda	Polar Bear	Black Bear	Brown Bear	Sun Bear
24 Which is the most recent species?						
25 Which is the largest looking bear?						
26 Which is the smallest bear?						
27 Which bear eats plants?						
28 Which bear eats insects?						

Questions 29-30

Circle **TWO** letters **A-F**.

Which **TWO** actions are mentioned to help bears survive?

- A breeding bears in captivity
- B encouraging a more humane attitude
- C keeping bears in national parks
- D enforcing international laws
- E buying the speaker's book
- F writing to the United Nations

SECTION 4 **Questions 31-40**

Questions 31-36

Circle the correct letters **A-C**.

- 31 The speaker compares a solar eclipse today to a
- A religious experience
 - B scientific event.
 - C popular spectacle.
- 32 The speaker says that the dark spot of eclipse is
- A simple to predict
 - B easy to explain
 - C randomly occurring
- 33 Concerning an eclipse, the ancient Chinese were
- A fascinated
 - B rational
 - C terrified

CRACK IELTS IN A FLASH (LISTENING)

- 34 For the speaker, the most impressive of an eclipse is the
 A exceptional beauty of the sky.
 B chance for scientific study.
 C effect of the moon on the sun.
- 35 Eclipses occur rarely because of the size of the
 A moon.
 B sun.
 C earth.
- 36 In predicting eclipses, the Babylonians were restricted by their
 A religious attitudes.
 B inaccurate observations.
 C limited ability to calculate.

Questions 37-40

Complete the table below.

Write **NO MORE THAN THREE WORDS** for each answer.

Date of eclipse	Scientists	Observation
1715	Halley	37 who accurately predicted an eclipse
1868	Janssen & Lockyer	discovered 38
1878	Watson	believed he had found 39
1919	Einstein	Realized astronomers had misunderstood 40

Test 10

SECTION 1

Questions 1 - 10

Questions 1-4

Listen to two students, Louise and Kerry, talking about their vacation.

Answer the questions below.

Use **NO MORE THAN THREE WORDS OR A NUMBER** for each answer.

Example: Where did Louise spend her summer holidays? **Europe**

1. How much was a Eurailpass Youth Ticket?.....
2. How many European countries did Louise's ticket allow her to travel to?
.....
3. Did the Eurailpass Youth Ticket include the train from London to Paris?
.....
4. How old must you be if you want to purchase a Eurailpass Youth ticket?
.....

Questions 5 - 10

Complete the notes below.

Use **NO MORE THAN THREE WORDS** for each answer.

Points that Louise makes about Eurail:

- easy to travel to small towns
- easy to meet **5**
- **6** with times of the trains
- night-trains had many **7** as passengers

Advice that Louise gives about Eurail:

- Don't take **8** bags
- Be **9** with your belongings
- Spend enough time in each country to experience **10**

SECTION 2

Questions 11 - 20

Questions 11 - 16

Complete the table below.

Use **NO MORE THAN THREE WORDS** for each answer.

Central City University - Student Support Services		
Academic Support Services	Course Content & Assessment Advisors (11)	- counseling re: course selection - language support
Library Services	Research & Resource Department Study Skills Department (13)	- assistance and advice for research and library use - assistance with arranging (12)
Administration Student Services	Administration Officers (14) Homestay Officer Student Employment Officer (15)	- issuing student cards - independent accommodation advice - family-style accommodation advice - part-time and vacation employment - inquiries re: passports and visas - retail outlet
Student Union Services	Bookshop Student Counseling Service Equal Opportunity Services Activity & Clubs Services	- counseling re: (16) problems - petitioning and sexual harassment - availability of clubs and activity schedules

Questions 17- 20

Match the names of the buildings with the letters on the map below.

- 17 The Library 18 Administration Building
19 Bookshop 20 International Student Advisor

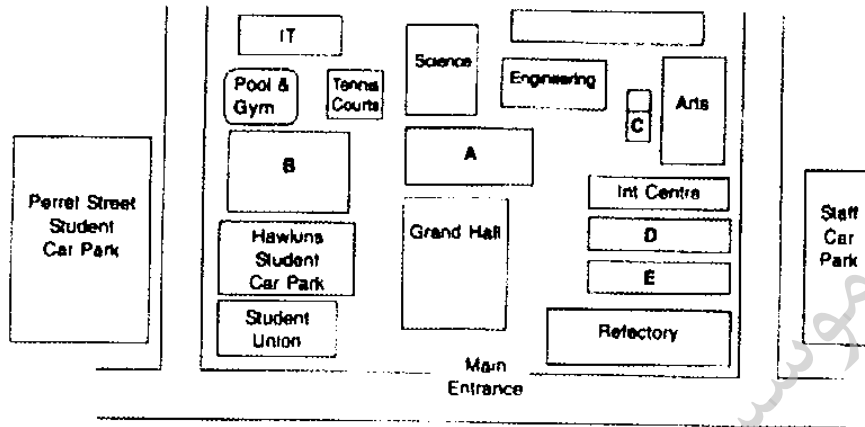

SECTION 3 Questions 21 - 30

Questions 21 - 22

Choose the correct letter from A - C.

- 21 Rose's plan for the tutorial is to research and present
A. the differences between male and female children.
B. the different ways that male and female children are raised.
C. the differences between male and female parenting.
- 22 The British experiments that Rose refers to in the conversation
A. were carried out in 100 families.
B. observed girls and boys who were raised identically.
C. noted the different treatments male and females received.

Questions 23 - 26

Choose **TWO** letters from A - E for each answer.

23 & 24 This tutorial will

- A. require Marie and Hose to carry out research.
- B. interest the tutor and their classmates.
- C. be tested.
- D. help Marie to catch up on her research work.
- E. benefit other assessment that Rose and Marie have to do.

25 & 26 Before starting their preparation, Marie and Rose must

- A. catch up on other work.
- B. agree on the topic.
- C. get approval from the tutor.
- D. make an appointment to see a librarian.
- E. plan carefully for the next two weeks.

Questions 27 - 30

Complete the form below.

Use **NO MORE THAN THREE WORDS** for each answer.

Proposed Tutorial Topics			
Tutor: <i>Jim Clark</i> Department: (27)		Subject Code: <i>EC101</i>	
Topic: <i>'How The Sexes Differ'</i> Aims of Tutorial: 1. To show (28)		Time: <i>11 a.m.</i> Room: <i>B1203</i>	
2. To show the differences are (29)			
Day & Date of tutorial: <i>Tuesday 26th</i>			
A/V Equipment request			
TV	Tape Recorder	Video	Overhead Projector
(30) How do you want to be noticed of lecturer's approval?			
PHONE	LETTER	FAX	IN PERSON

SECTION 4 Questions 31 - 40

Questions 31 - 32

Complete the following sentences.

Use **NO MORE THAN THREE WORDS** for each answer:

31. The speaker identifies the following two differences between being a high school student and a university student:

- the academic expectations of tutors and lecturers are.....
- students must take responsibility for their own learning.

32. The speaker aims to get students to recognise exam stress and the way it can affect

Questions 33 - 36

Complete the table below.

Use **NO MORE THAN THREE WORDS** for each answer.

EXAM STRESS	
Signs	Effective Management includes:
Physiological: Increased pulse-rate Perspiration Breathing problems Problems with (33)	(34) breathing exercises
Psychological: Irrational (35) Panic	Be confident and (36) Be calm and analyse the questions

Questions 37- 40

Complete the following notes.

Use **NO MORE THAN THREE WORDS** for each answer.

37. Time needed to study effectively will according to individuals.

38. Time Management involves taking notice of the allocation of to exam questions.

39. To achieve good grades in examinations at university, you need to:

- have academic ability
- be
- think clearly
- observe time management practices

40. Students wishing to develop their can attend next week's workshop.

موسسه تحقیقاتی آرمان